

COASTER[®]
FINE FURNITURE

100872

GAME CHAIR

**ASSEMBLY INSTRUCTION
COASTER FINE FURNITURE**



www.coastercompany.com

Assembly Instruction

ASSEMBLY TIPS:









1. Remove hardware from box and sort by size.
2. Please check to see that all hardware and parts are present prior to start of assembly.
3. Please follow attached instructions in the same sequence as numbered to assure fast & easy assembly.

Warning !





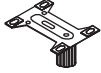







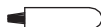

1. Don't attempt to repair or modify parts that are broken or defective .Please contact the store immediately.
2. This product is for home use only and not intended for commercial establishment.

PARTS IDENTIFICATION:

	AA	LEFT ARMREST	1 PC
	AB	RIGHT ARMREST	1 PC
	B	BACKREST	1 PC
	C	SEAT	1 PC
	D	BASE	1 PC
	E	CASTER	5 PCS
	F	WOODEN COVER	1 PC
	G	SEAT PLATE	1 PC
	H	SUPPORTING BAR	1 PC

Z HARDWARE PACKAGE

NO	DESCRIPTION	FIGURE	Q'TY
1	LARGE BOLT		2 PCS
2	SMALL BOLT		4 PCS
3	METAL WASHER		10 PCS
4	13mm -HEX NUT		4 PCS
5	70mm - SCREW		2 PCS
6	GLUE		1 PC
7	ALLEN WRENCH		1 PC
8	SPANNER		1 PC
9	WOODEN PLUG		2 PCS
10	LARGE SPRING WASHER		4 PCS
11	SMALL SPRING WASHER		6 PCS
12	WOOD SCREW		4 PCS
13	SLICE SWITCHING		2 PCS

STEP 1:

Insert the Casters (E) into the Base (D) , then insert the Supporting Bar (H) into the Base (D) center with a plastic hammer , insert the Wooden Cover (F) through the Supporting Bar (H) .

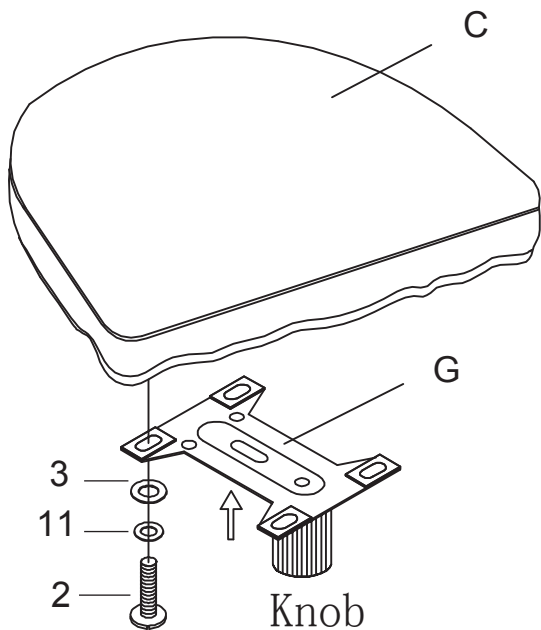
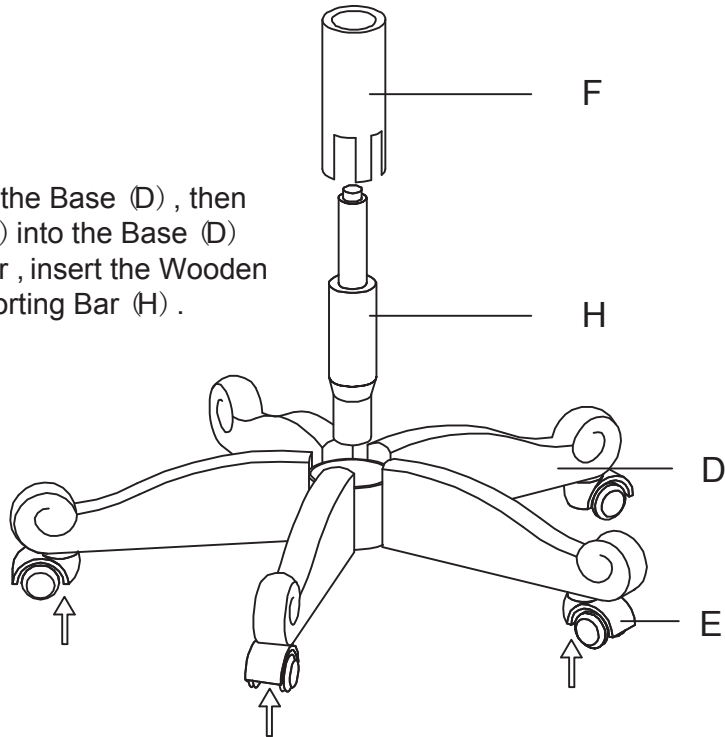

STEP 2:

Attach the Seat Plate (G) to the Seat (C) with Bolt (2) , Small Spring Washer (11) and Metal Washer (3).
(The Knob on the Seat Plate (G) facing forwards)

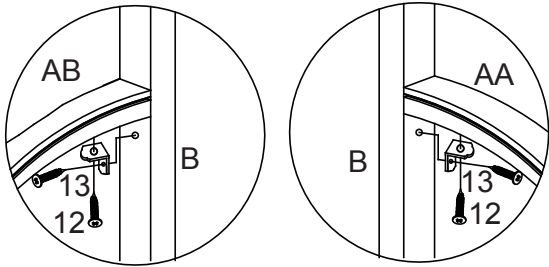

STEP 3:

Attach the Backrest (B) to the Seat (C) with Washer (3), Small Spring Washer (11) and Large Bolt (1), then attach the Armrests (AA,AB) to the Seat (C) with Washer (3), Large Spring Washer (10) and Nut (4) and to the Backrest (B) with Screw (5). (Put Wooden Plug (9) into the interface)

Use Wood Screw (12) through Slice Switching (13) to Backrest (B) and Armrests(AA,AB).

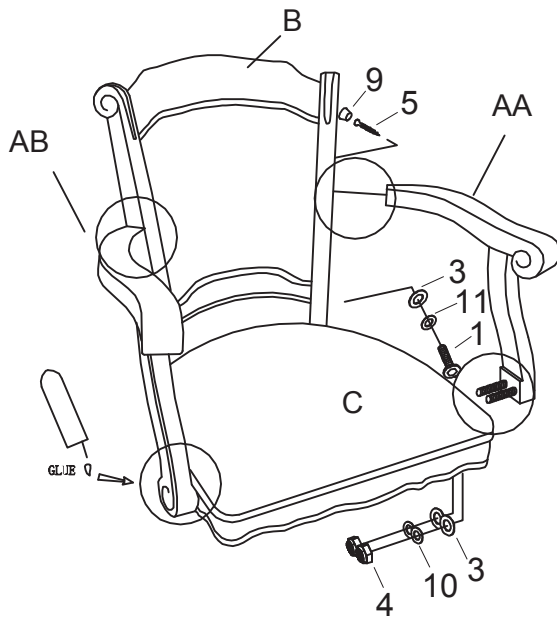

STEP 4:

Place the Seat (C) onto the Supporting Bar (H) through the hole under the Seat Plate (G).

