



107513
LIVE EDGE
BENCH

ASSEMBLY INSTRUCTIONS



www.coastercompany.com

ASSEMBLY TIPS:

1. Remove hardware from box and sort by size.
2. Please check to see that all hardware and parts are present prior to start of assembly.
3. Please follow attached instructions in the same sequence as numbered to assure fast & easy assembly.



Warning!

1. Don't attempt to repair or modify parts that are broken or defective. Please contact the store immediately.
2. This product is for home use only and not intended for commercial establishment.

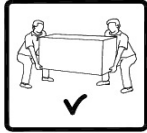



ASSEMBLY TIME

10 MINUTES

PARTS IDENTIFICATION

A		SEAT	1PC
B		LEG FRAME	2PCS

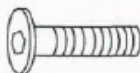
HARDWARE IDENTIFICATION

1		BOLT	8PCS
2		FLAT WASHER	8PCS
3		ALLEN WRENCH	1PC

STEP 1

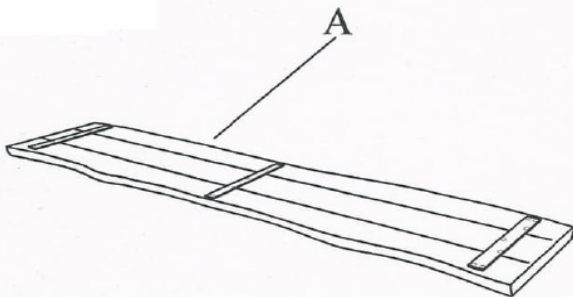

STEP 2

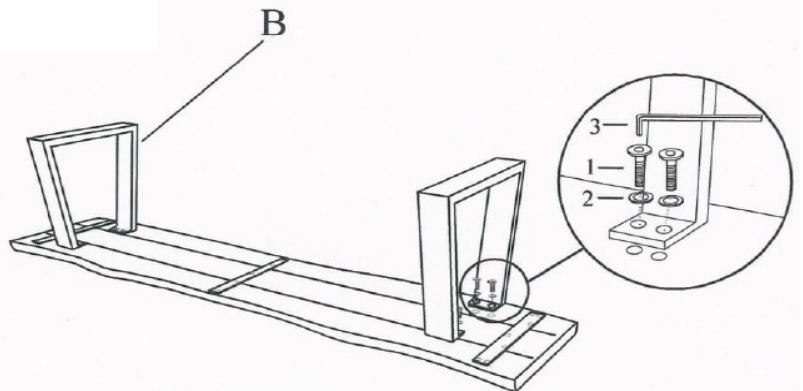

STEP 3

