



204185

CHEST

**ASSEMBLY INSTRUCTIONS
COASTER FINE FURNITURE**



www.coastercompany.com

ASSEMBLY TIPS:

- 1. Remove hardware from box and sort by size
- 2. Please check to see that all hardware and parts are present prior to start of assembly.
- 3. Please follow attached instruction in the same sequence as numbered to assure fast & easy assembly.



Warning!

- 1. Don't attempt to repair or modify parts that are broken or defective. Please contact the store immediately.
- 2. This product is for home use only and not intended for commercial establishment.

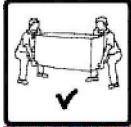

ASSEMBLY TIME 15 MINUTES

PARTS IDENTIFICATION

A CHEST 1PC

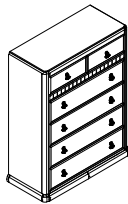

B BUN FOOT 4PCS

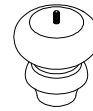

STEP 1

Bun Feet Are Inside
the Bottom Drawer

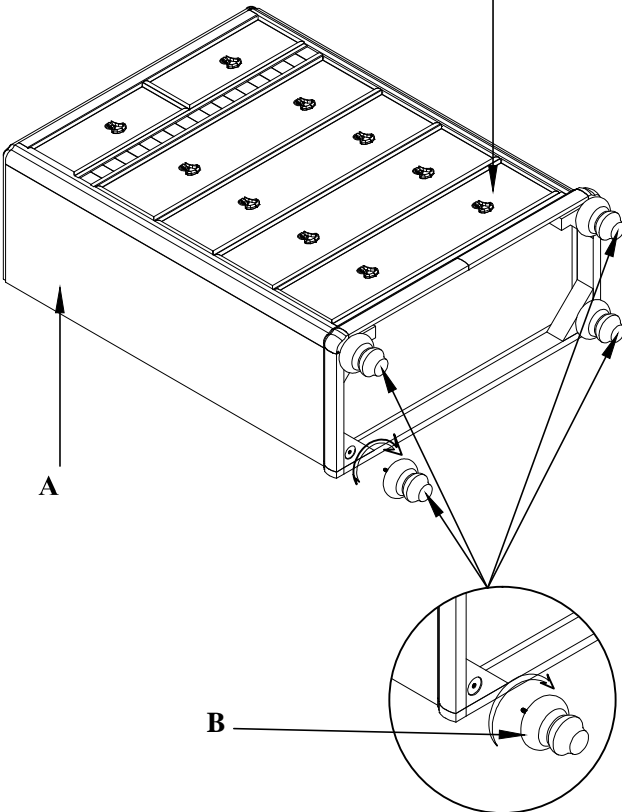

STEP 2

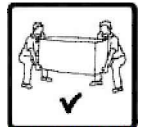
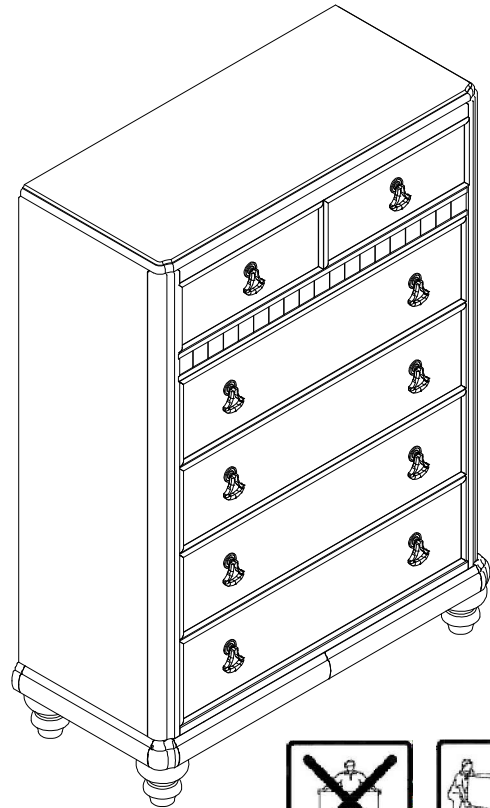



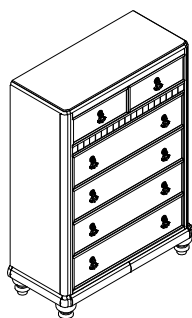

ANTI-TIPPING KIT

PARTS IDENTIFICATION

A CHEST 1PC

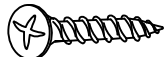

HARDWARE IDENTIFICATION

1		L-BRACKET	2PCS
2		CABLE TIE	1PC
3		LONG SCREW	1PC
4		SHORT SCREW	1PC
5		PLASTIC ANCHOR	1PC

- 1.1 Attach one of the mounting brackets securely to the back edge of the chest. Use the short screw.
- 1.2 Determine where the chest is to be placed and mark location on the wall for the mounting bracket screw hole approximately 2" below the bracket mounted to the edge of the chest.
- 1.3 Drill a 3/16" hole in the wall. Press the plastic anchor into the hole and gently tap until the flange on the anchor is against the wall surface.
- 1.4 Position the bracket over the anchor and use the long screw to securely attach the brackets to the wall.
- 1.5 Place the chest so the bracket on the back edge is in line with the bracket on the wall.
- 1.6 Lace an end of the cable tie down through each bracket. Bring both ends together and slide the beaded end of the cable tie through the keyhole shaped slot on the other end until snug. Pull down on the beaded end until it snap locks into the keyhole slot.
- 1.7 To double lock return the beaded end back through the keyhole as shown.
- 1.8 Check to make sure the cable tie is securely laced and locked to the brackets.

