

COASTER[®]
FINE FURNITURE

204192

NIGHT STAND

ASSEMBLY INSTRUCTIONS
COASTER FINE FURNITURE



www.coastercompany.com

ASSEMBLY TIPS:

- 1 . Remove hardware from box and sort by size.
- 2 . Please check to see that all hardware and parts are present prior to start of assembly.
- 3 . Please follow attached instructions in the same sequence as numbered to assure fast & easy assembly.



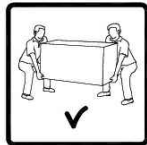

Warning !

- 1 . Don't attempt to repair or modify parts that are broken or defective. Please contact the store immediately.
- 2 . This product is for home use only and not intended for commercial establishment.





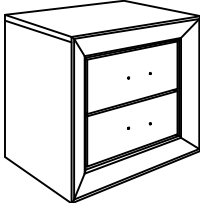
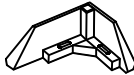
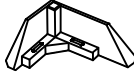
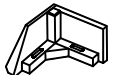

ASSEMBLY TIME	15 MINUTES
---------------	------------

PARTS IDENTIFICATION

A.		NIGHT STAND	1 PC
B.		RIGHT FRONT LEG	FR 1 PC
C.		LEFT FRONT LEG	FL 1 PC
D.		RIGHT BACK LEG	BR 1 PC
E.		LEFT BACK LEG	BL 1 PC

HARDWARE IDENTIFICATION

1.		BOLT	8 PCS
2.		LOCK WASHER	8 PCS
3.		FLAT WASHER	8 PCS
4.		ALLEN WRENCH	1 PC

NOTE : PHILLIPS HEAD SCREW DRIVER IS REQUIRED IN THE ASSEMBLY PROCESS. HOWEVER, MANUFACTURER DOES NOT PROVIDE THIS ITEM.

STEP 1

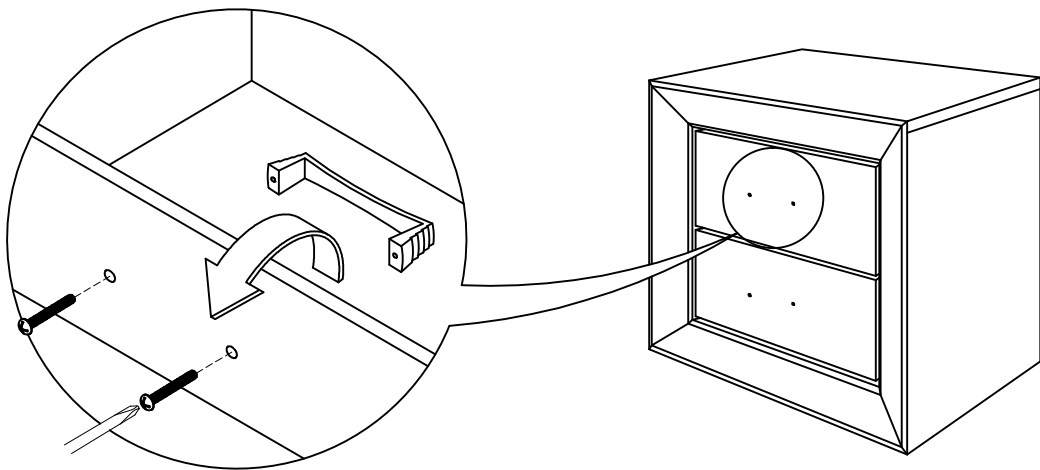

STEP 2

