



**204543**

**DRESSER**

ASSEMBLY INSTRUCTIONS  
COASTER FINE FURNITURE



[www.coastercompany.com](http://www.coastercompany.com)

**ASSEMBLY TIPS:**

- 1. Remove hardware from box and sort by size.
- 2. Please check to see that all hardware and parts are present prior to start of assembly.
- 3. Please follow attached instruction in the same sequence as numbered to assure fast & easy assembly.



**Warning!**

- 1. Don't attempt to repair or modify parts that are broken or defective. Please contact the store immediately.
- 2. This product is for home use only and not intended for commercial establishment.

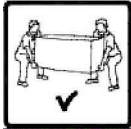

ASSEMBLY TIME 2 MINUTES

**PARTS IDENTIFICATION**

A DRESSER 1PC

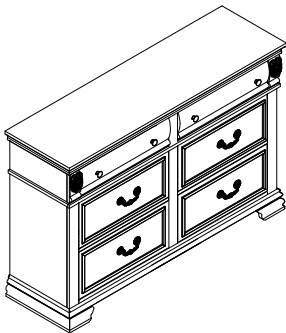

**STEP 1**

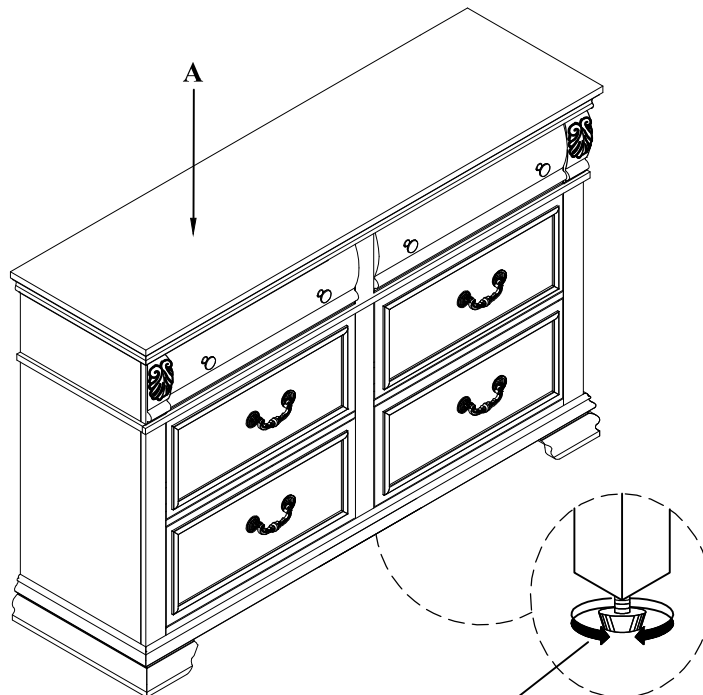

Adjustable Leveler

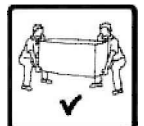



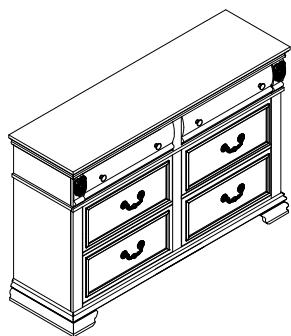

## ANTI-TIPPING KIT

### PARTS IDENTIFICATION

**A DRESSER 1PC**

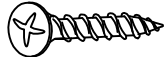

### HARDWARE IDENTIFICATION

|   |  |                |      |
|---|--|----------------|------|
| 1 |  | L-BRACKET      | 2PCS |
| 2 |  | CABLE TIE      | 1PC  |
| 3 |  | LONG SCREW     | 1PC  |
| 4 |  | SHORT SCREW    | 1PC  |
| 5 |  | PLASTIC ANCHOR | 1PC  |

- 1.1 Attach one of the mounting brackets securely to the back edge of the dresser. Use the short screw.
- 1.2 Determine where the dresser is to be placed and mark location on the wall for the mounting bracket screw hole approximately 2" below the bracket mounted to the edge of the dresser.
- 1.3 Drill a 3/16" hole in the wall. Press the plastic anchor into the hole and gently tap until the flange on the anchor is against the wall surface.
- 1.4 Position the bracket over the anchor and use the long screw to securely attach the brackets to the wall.
- 1.5 Place the dresser so the bracket on the back edge is in line with the bracket on the wall.
- 1.6 Lace an end of the cable tie down through each bracket. Bring both ends together and slide the beaded end of the cable tie through the keyhole shaped slot on the other end until snug. Pull down on the beaded end until it snap locks into the keyhole slot.
- 1.7 To double lock return the beaded end back through the keyhole as shown.
- 1.8 Check to make sure the cable tie is securely laced and locked to the brackets.

