

COASTER[®]
Fine Furniture

300075

BENCH WITH THREE DRAWER

ASSEMBLY INSTRUCTION
COASTER FINE FURNITURE



www.coastercompany.com

Assembly Instruction

























ASSEMBLY TIPS:

1. Remove hardware from box and sort by size.
2. Please check to see that all hardware and parts are present prior to start of assembly.
3. Please follow attached instructions in the same sequence as numbered to assure fast & easy assembly.



Warning !

1. Don't attempt to repair or modify parts that are broken or defective. Please contact the store immediately.
2. This product is for home use only and not intended for commercial establishment.

| PARTS IDENTIFICATION: | | | | Z | HARDWARE PACKAGE | | |
|-----------------------|---------------------|---|-------------|----|--------------------------------|---|--------|
| A | LEFT SIDE ARMREST |  | 1 PC | 1 | BOLT |  | 12 PCS |
| B | RIGHT SIDE ARMREST |  | 1 PC | 2 | WOOD PLUG |  | 12 PCS |
| C | BACK RAIL |  | 1 PC | 3 | SCREWS |  | 42 PCS |
| D | LEFT SIDE APRON |  | 1 PC | 4 | ALLEN WRENCH |  | 1 PC |
| E | RIGHT SIDE APRON |  | 1 PC | 5 | CROSS DOWEL BARREL NUT |  | 12 PCS |
| F | BACK APRON |  | 1 PC | 6 | WOOD DOWEL |  | 32 PCS |
| G | FRONT APRON |  | 1 PC | 7 | GLUE |  | 1 PC |
| H | SEAT PANEL |  | 1 PC | 8 | DRAWER SUPPORT |  | 3 PCS |
| I | SEAT SUPPORT FRAME |  | 3 PCS | 9 | DRAWER STOP |  | 3 PCS |
| J | DRAWER BACK PANEL |  | 3 PCS | 10 | DRAWER STEADY FRAME LEFT&RIGHT |  | 3 SET |
| K | DRAWER BOTTOM PANEL |  | 3 PCS | 11 | SCREWS |  | 18 PCS |
| L | LEFT DRAWER PANEL |  | 3 PCS | | | | |
| M | RIGHT DRAWER PANEL |  | 3 PCS | | | | |
| N | DRAWER FACE PANEL |  | 3 PCS | | | | |

It needs two persons and takes about sixty minutes to assemble the item.

STEP 1

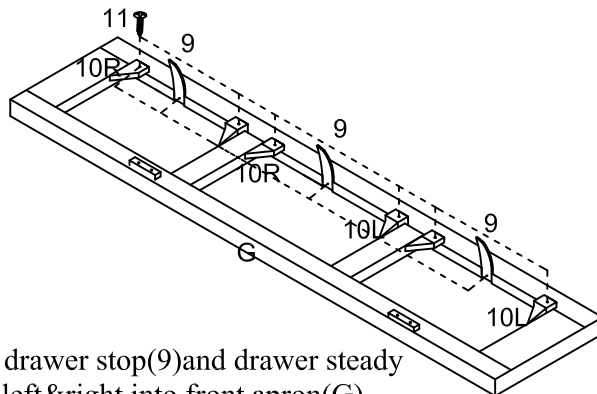

Attach the drawer stop(9)and drawer steady frame(10)-left&right into front apron(G) tighten with screw(11).

STEP 2

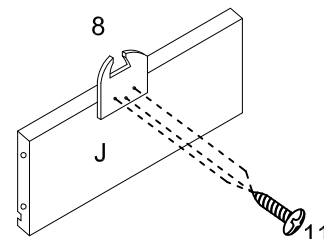

Attach screw(11)tighten the drawer support(8) to back panel(J)as figure shown.

STEP 3

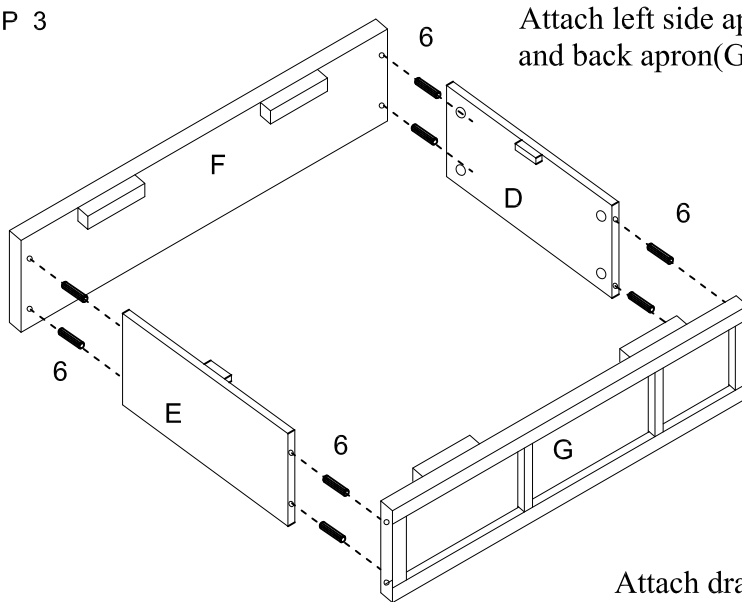

Attach left side apron(E)assemble right side apron(D)&front and back apron(G&F) with wood dowels(6).

STEP 4

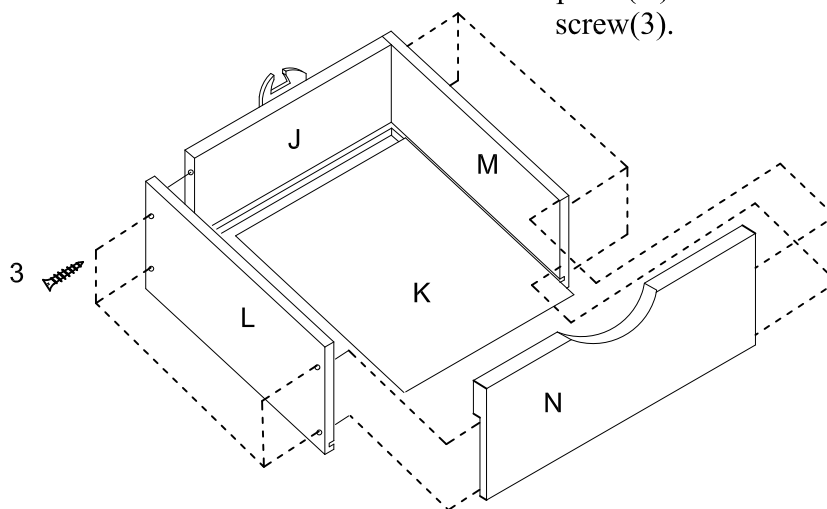

Attach drawer back panel(J)and left and right side panel(L&M)tighten with screw(3),insert bottom panel(K)and attach drawer face panel(N) tighten with screw(3).

STEP 5

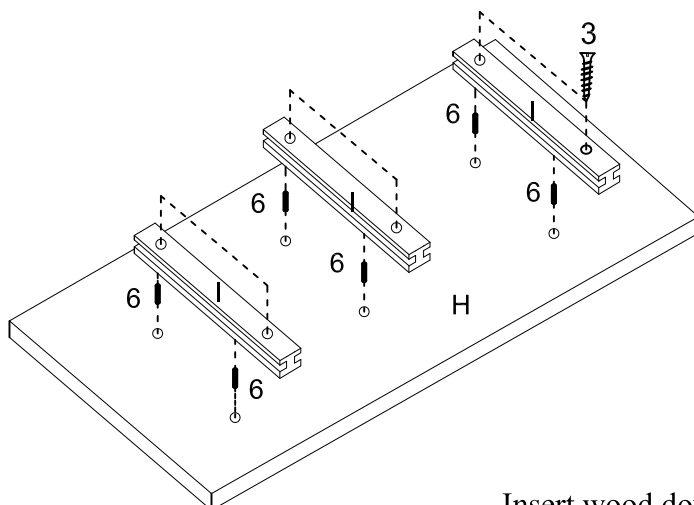

Insert wood dowels(6)into the hole ,attach seat support frame(I)to the seat panel tighten with screw(3).

STEP 6

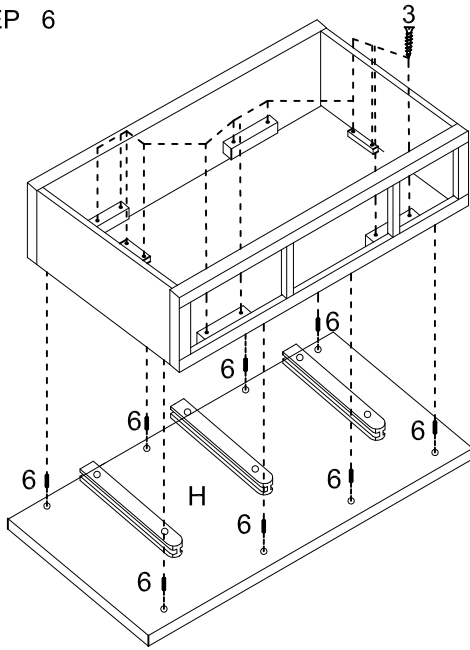

Assemble seat panel(H)and storage frame with screw(3)and wood dowel(6).

STEP 7

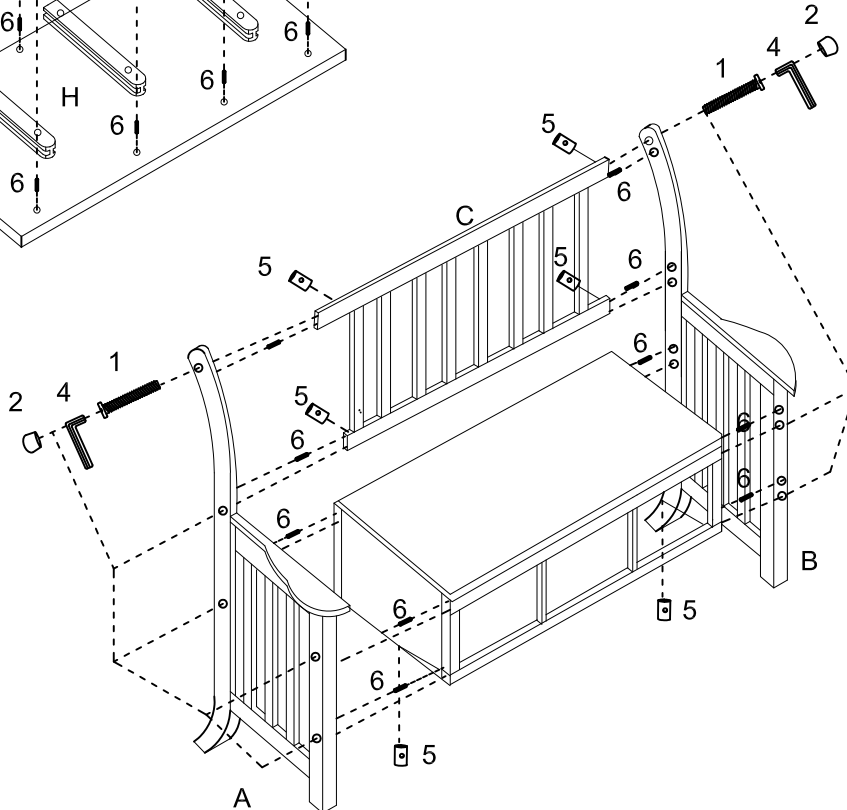

Attach left armrest(A)with storage with wood dowel(6).then insert bolts(1) through the left armrest(A)into cross dowel barrel nut(5) and tighten with allen wrench(4). Attach back rail(C),then insert bolts(1) through the left armrest(A) into hanger bolts and tighten with allen wrench(4). Assemble another armrest likewise.then insert wood plug(2) to the holes of armrest as figure shown.

STEP 8

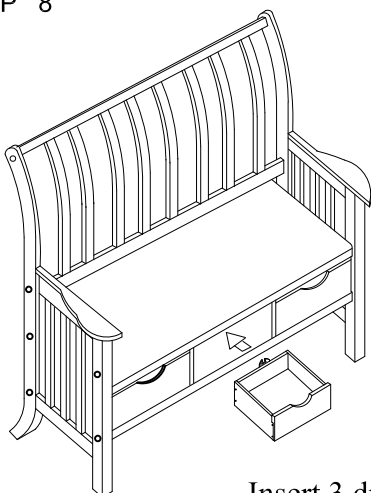

Insert 3 drawer to the seat frame.

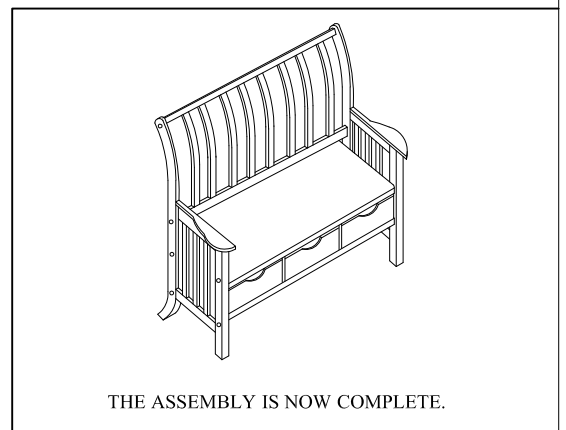

THE ASSEMBLY IS NOW COMPLETE.