

COASTER®
Fine Furniture

300698Q

QUEEN SIZE BED

ASSEMBLY INSTRUCTIONS
COASTER FINE FURNITURE



www.coastercompany.com

www.coastercompany.com

ASSEMBLY TIPS:

- 1.Remove hardware from box and sort by size.
- 2.Please check to see that all hardware and parts are present prior to start of assembly.
- 3.Please follow attached instructions in the same sequence as numbered to assure fast & easy assembly.

warning

- 1.Don't attempt to repair or modify parts that are broken or defective please contact the store immediately.
- 2.This product is for home use only and not intended for commercial establishment.

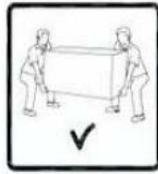

ASSEMBLY TIME PER UNIT:

30 MINUTES

PARTS IDENTIFICATION



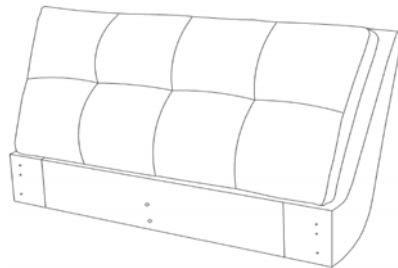

A

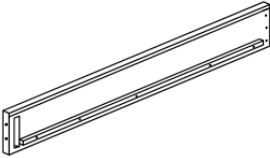
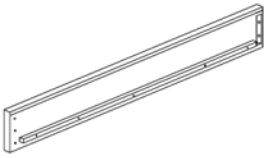
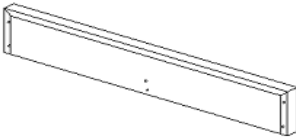
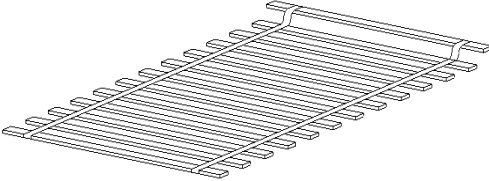

HEADBOARD 1PC

All above part pack in located in 300698QB1

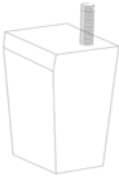
PARTS IDENTIFICATION

B		LEFT BED RAIL 1PC
C		RIGHT BED RAIL 1PC
D		FOOTBOARD 1PC
E		ROLL OF SLAT 1PC
F		SLAT SUPPORT 1 PC
G		LEG 4 PCS
H		SLAT SUPPORT WITH LEVELER 2 PCS

HANDWARE PACKAGE

FIGURE		DESCRIPTION	QUANTITY	FIGURE		DESCRIPTION	QUANTITY
1		Threaded bolt M8*90mm	8PCS	9		Allen wrench S4	1PC
2		Spring Washer M8	16PCS	10		Allen wrench S5	1PC
3		Flat Washer Ø6* Ø18*1mm	4PCS	11		Plastic Washer	6PCS
4		Flat Washer Ø 8*Ø22*2mm	16PCS	12		LEFT RAIL HOOK	1PC
5		Nut Ø8*13mm	8PCS	13		RIGHT RAIL HOOK	1PC
6		Allen head bolt M8*40mm	8PCS	14		Wrench Ø8m	1PC
7		Allen head bolt M6*40mm	4PCS				
8		Spring Washer M6	4PCS				

All above hardware pack in located in 300698QB2

STEP 1

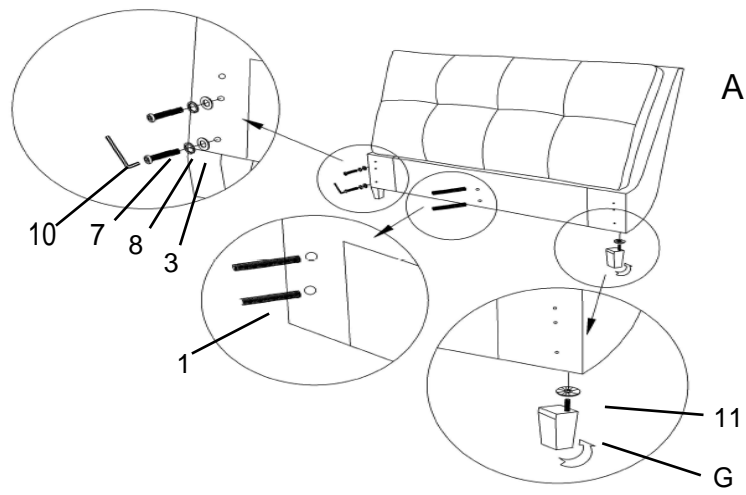

STEP 2

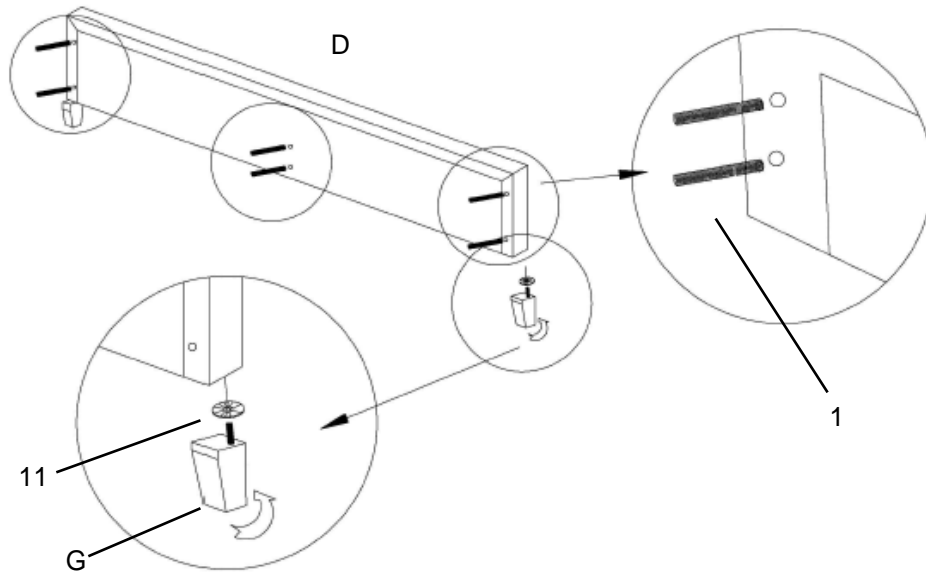

STEP 3

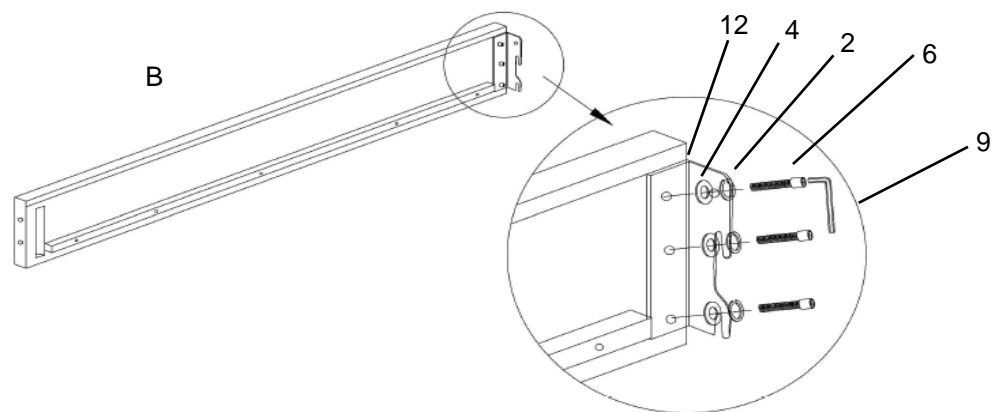

STEP 4

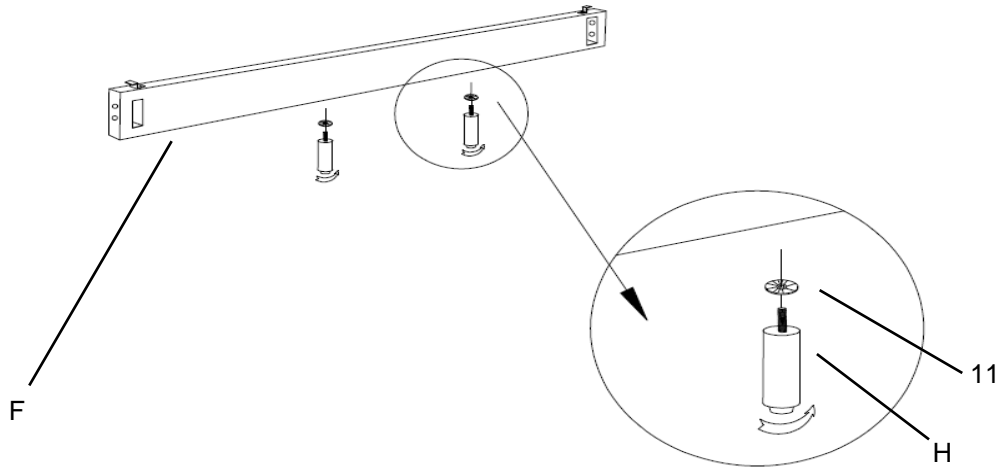

STEP 5

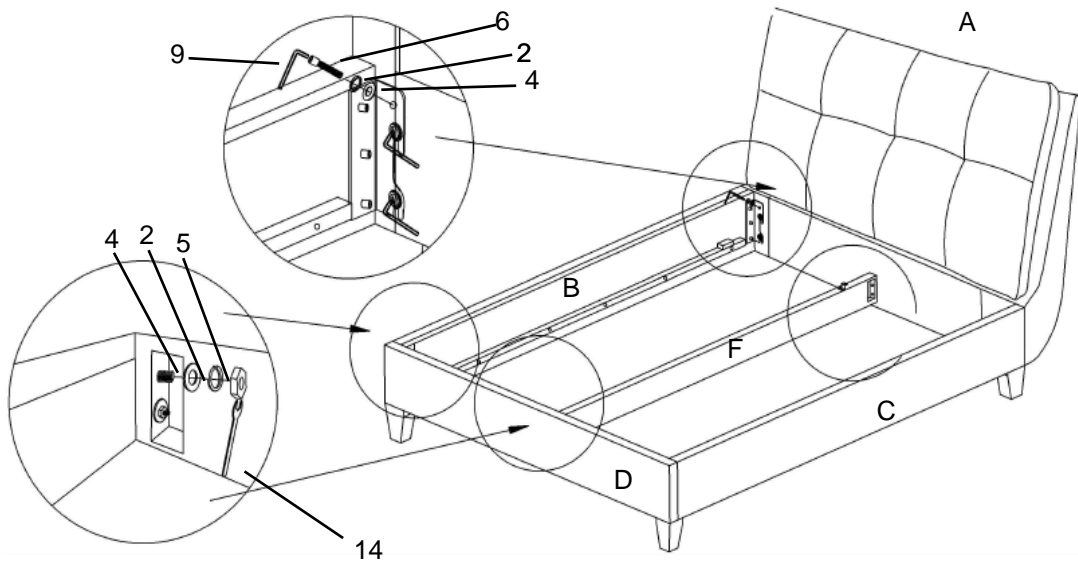

STEP 6

