

COASTER[®]
FINE FURNITURE

400155T
CARRIAGE BED

ASSEMBLY INSTRUCTION
COASTER FINE FURNITURE



www.coastercompany.com

04/03/2014

ASSEMBLY INSTRUCTIONS

ASSEMBLY TIPS:





1. Remove hardware from box and sort by size.
2. Please check to see that all hardware and parts are present prior to start of assembly.
3. Please follow attached instructions in the same sequence as numbered to assure fast & easy assembly.





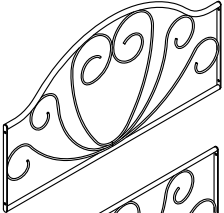

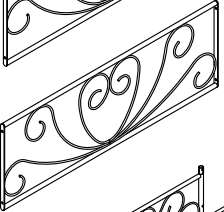
Warning !

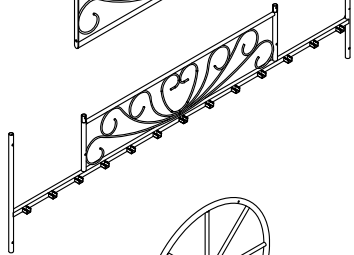
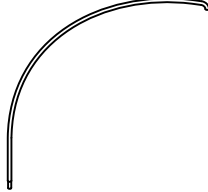
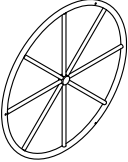
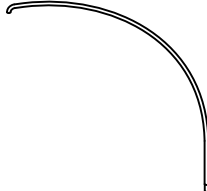
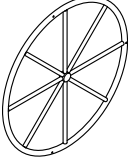
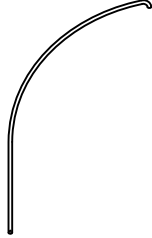
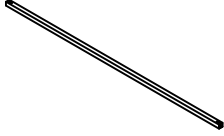
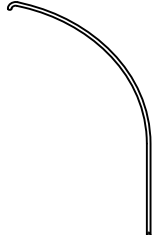
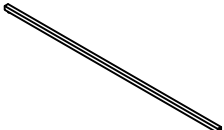
1. Don't attempt to repair or modify parts that are broken or defective . Please contact the store immediately.
2. This product is for home use only and not intended for commercial establishment.

PARTS IDENTIFICATION

A	Headboard		1pc	H	Metal cap		1pc
B	Footboard		1pc	I	Decorative finial		1pc
C	Side Panel		2pcs	J	Canopy tube 1		2pcs
D	Decorative wheel 1		2pcs	K	Canopy tube 2		2pcs
E	Decorative wheel 2		2pcs	L	Canopy tube 3		2pcs
F	Bed slats 1		1pc	M	Canopy tube 4		2pcs
G	Bed slats 2		12pcs				

PARTS IDENTIFICATION

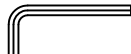

Z	HARDWARE PACKAGE FOR TV STAND		
NO	DESCRIPTION	FIGURE	Q`TY
1	BOLT 1/4"x1/2"		9PCS
2	BOLT 1/4"x1/2"		12PCS
3	BOLT 1/4"x1-1/8"		2PCS
4	BOLT 1/4"x1-1/4"		12PCS
5	WASHER		10PCS
6	ALLEN WRENCH		1PC
7			
8			
9			
10			
11			
12			
13			
14			
15			
16			
32			

ASSEMBLY

Do not fully tighten all bolts until assembly is complete.
This will help all parts to assemble properly.



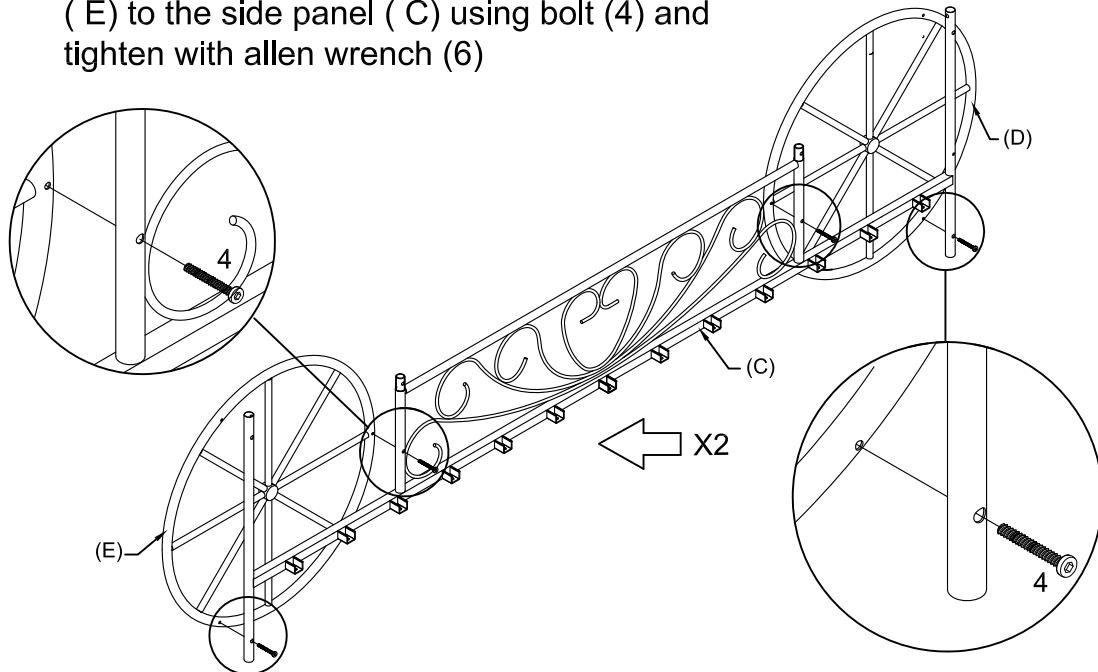

Assembly time 20 minutes. Two people needed.

STEP 1: Align and attach the decorative wheels (D) and (E) to the side panel (C) using bolt (4) and tighten with allen wrench (6)

- | | | |
|---|---|-------|
| 4 |  | 8 pcs |
| 6 |  | |



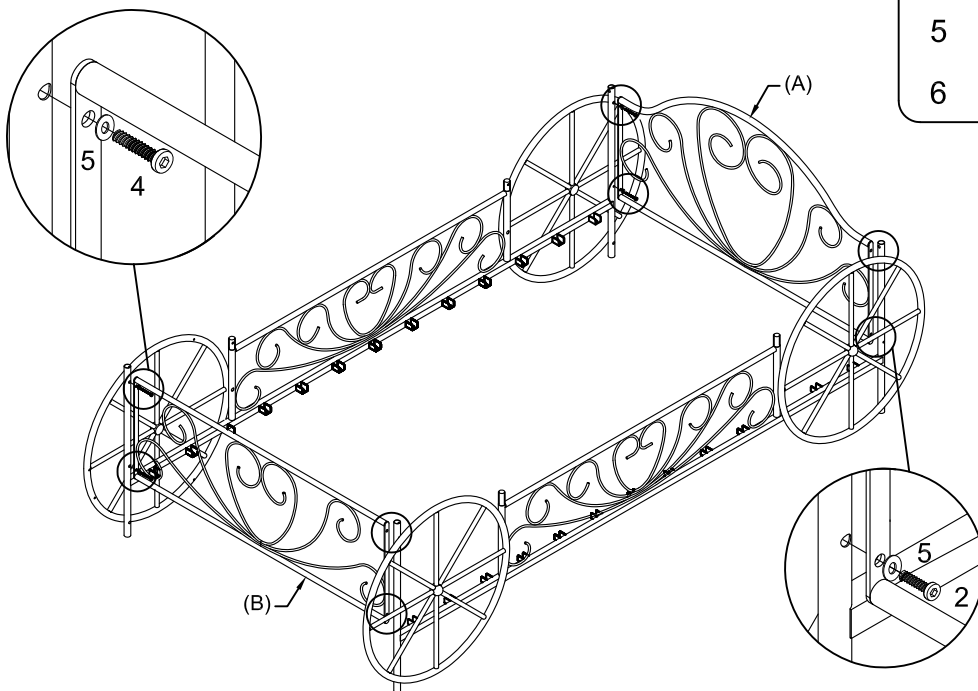

STEP 2: Align and attach the Headboard (A) and Footboard (B) to the assembled side panels using bolt (4) and bolt (2), washer (5) and tighten with allen wrench (6)

- | | | |
|---|---|-------|
| 4 |  | 4 pcs |
| 2 |  | 4 pcs |
| 5 |  | 8 pcs |
| 6 |  | |



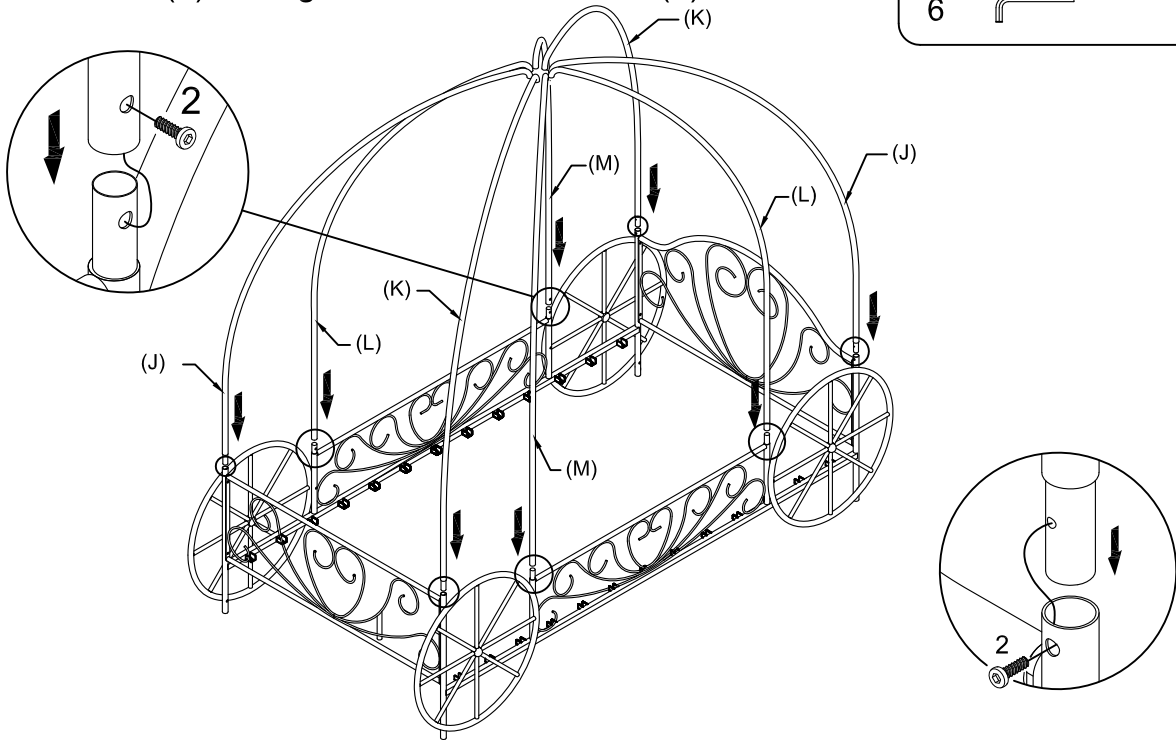

STEP 3: Align and attach the canopy tubes (J), (K), (L) and (M) to the assembled bed frame using bolt (2) and tighten with allen wrench (6)

2		8pcs
6		



STEP 4: Align and attach the metal cap(H) to the assembled canopy tubes using bolt (1) and tighten with allen wrench (6)

1		8pcs
6		

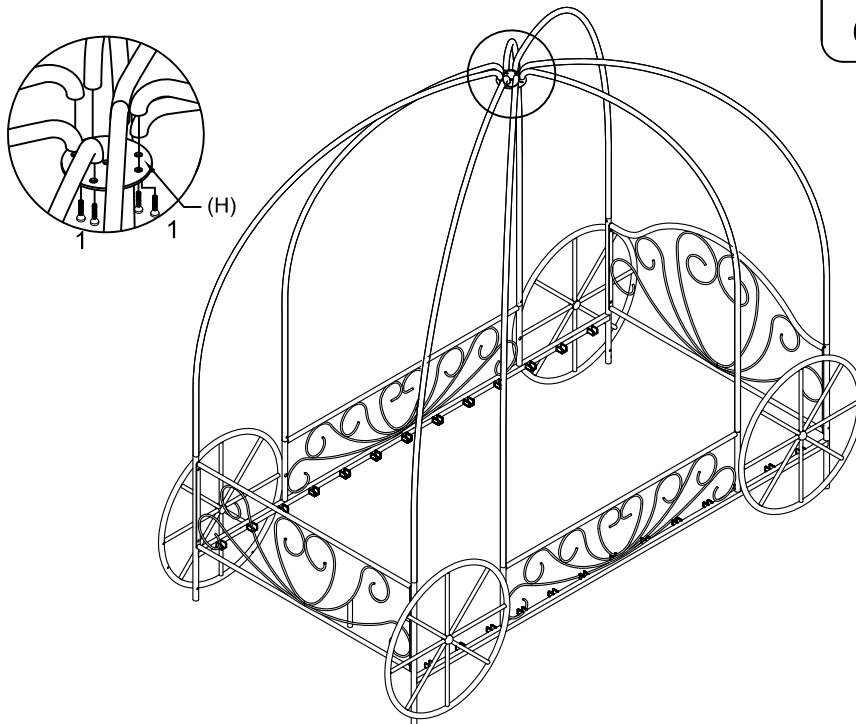

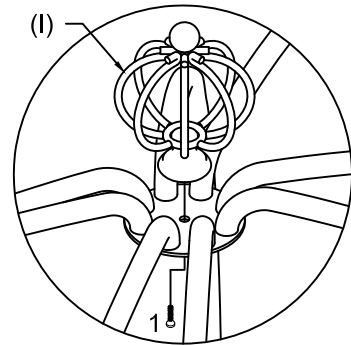
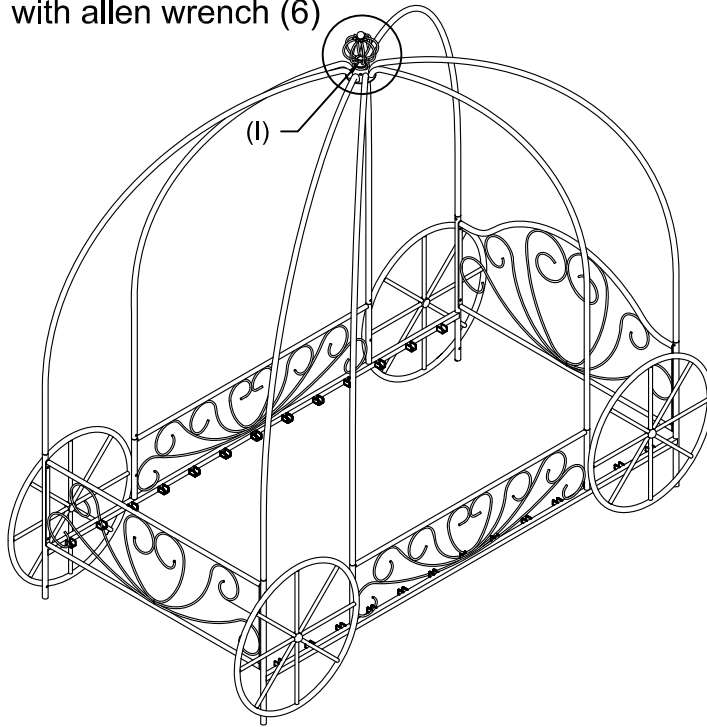
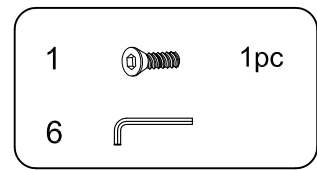

STEP 5: Align and attach the decorative finial (I) to the assembled metal cap using bolt (1) and tighten with allen wrench (6)

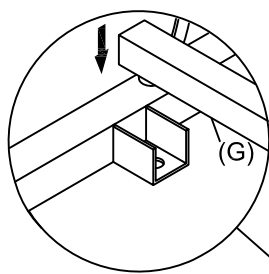
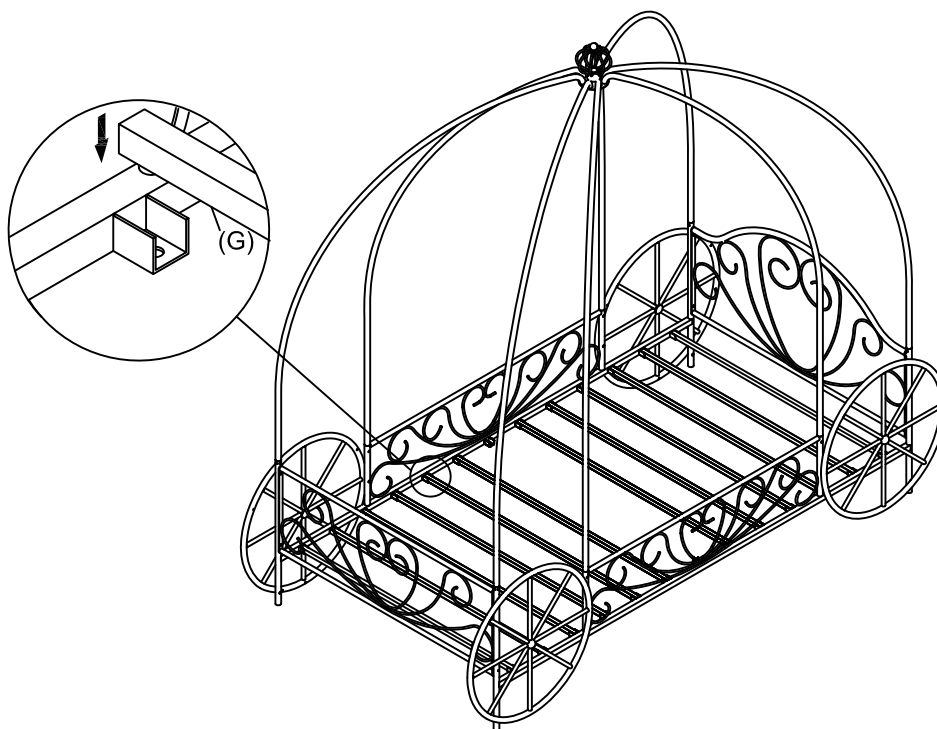

STEP 6: Align and attach the slats (G) to assembled side panels



STEP 6:Align and attach the slats (F) to assembled side panels using bolt (3) and washer (5) and tighten with allen wrench(6)

3		2pcs
5		2pcs
6		

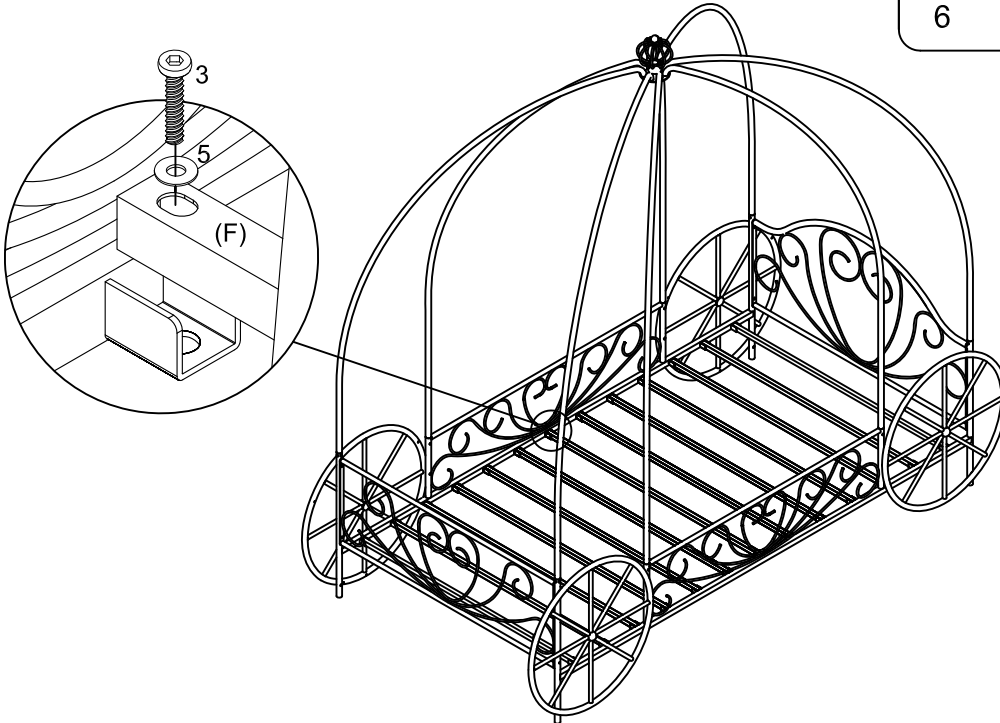

STEP 8:Complete

